

WYLER

WYLER PRODUCTS AND SERVICES WYLER-PRODUKTE UND -SERVICES



Version 2022
Edition 2

WYLER AG
INCLINATION MEASURING SYSTEMS
NEIGUNGSMESSSYSTEME

Im Holderli 13, CH-8405 WINTERTHUR (Switzerland)
Tel. +41 (0) 52 233 66 66 Fax +41 (0) 52 233 20 53
E-Mail: wyler@wylerag.com Web: www.wylerag.com



WYLER

SPIRIT LEVELS, CLINOMETERS,
VARIOUS SPECIAL PRODUCTS

WASSERWAAGEN, CLINOMETER,
SPEZIAL-PRODUKTE

SWISS  MADE



INTRODUCTION

EINFÜHRUNG

WYLER Spirit Levels have been known for decades all around the globe for their high precision, quality and reliability. All products are manufactured according to the relevant international standards and assure an extraordinary resistance against wear and geometrical deformation due to the use of selected and well matured materials.

The **SPIRIT LEVELS / PRECISION SPIRIT LEVELS** can be divided into the following types:

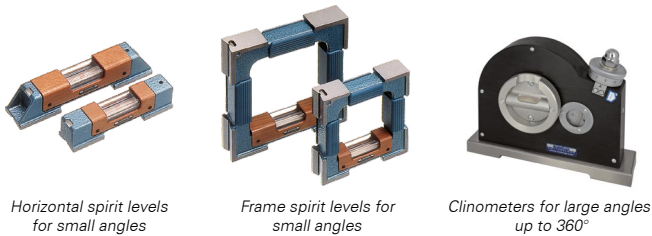

WYLER-Richtwaagen sind seit Jahrzehnten weltweit bekannt für höchste Präzision, Qualität und Zuverlässigkeit. Alle Produkte werden entsprechend den einschlägigen internationalen Normen hergestellt und gewährleisten dank ausgewählten, gealterten Materialien hohe Verschleissfestigkeit und Stabilität.

Bei **Richtwaagen / PRÄZISIONS-Richtwaagen** unterscheidet man zwischen:



Most spirit levels can be equipped with **magnetic inserts**.

Besides the vial, the frame or body of a precision level is extremely important. The material mostly from cast iron or special steel must be free from tension (distortion!). The treatment of the material before, during and after the machining and assembling is of greatest importance. Usually the bases of the levels for measuring surfaces have two contact faces. These allow the exact setting of the instrument. Prismatic bases with two contact faces are used for measuring round shafts and bars. A speciality of the WYLER precision levels lays in the fact that the geometry of the bases is adjusted exactly parallel to the vial axis by grinding and scraping.

Only by this precision work it is assured that even when the level is slightly tilted no measuring error occurs (twist stability). The specialist is aware of the temperature sensitivity of a spirit level. Therefore no direct sunlight is allowed on the level and draught is avoided, if a precise measurement is to be guaranteed.



Die meisten Richtwaagen können auch mit **Magneteinsätzen** geliefert werden.

Neben einer genauen Libelle ist natürlich die Qualität des Richtwaagenkörpers von entscheidender Bedeutung. Das Material, meistens Grauguss oder Spezialstahl, muss möglichst frei von Spannungen (Verzug!) sein. Die Behandlung des Materials vor und nach der Verarbeitung ist von entscheidender Bedeutung. Die Messbasen von Präzisions-Richtwaagen weisen in der Regel zwei Auflageflächen zum Kontrollieren von Flächen auf, die eine saubere Auflage auf dem Messobjekt garantieren.

Für Messungen auf Wellen sind die Richtwaagen mit zwei prismatischen Einschnitten versehen, die in der Mitte der Messflächen eingearbeitet sind. Zusätzlich können die Basen mit Magneteinsätzen versehen werden. Ein besonderes Merkmal der Präzisions-Richtwaagen von WYLER besteht darin, dass die Geometrie aller Messflächen durch Schleifen und manuelles Schaben genau parallel zur Libellenachse einjustiert werden kann.

Nur durch diese Präzisionsarbeit ist gewährleistet, dass auch bei einer leicht schräg (Twist) angesetzten Richtwaage keine Messfehler entstehen. Dem Fachmann ist die Temperaturempfindlichkeit von Präzisions-Richtwaagen bekannt. Deshalb vermeidet er direkte Sonneneinstrahlung und Zugluft am Einsatzort, um eine genaue Messung zu garantieren.

The user has the possibility to adjust the **ZERO** as well as the **TWIST** thanks to a simple adjustment system.

Dank den beiden Einstellschrauben können der **NULLPUNKT / ZERO** und die Querabweichung / **TWIST** durch den Benutzer auf einfachste Weise justiert werden.

Operating temperature range / Betriebstemperatur
Storage temperature range / Lagertemperatur

15 ... + 25°C
- 40 ... + 70°C

Standard dimensions of prismatic bases for shafts measurement
Standardabmessungen prismatischer Basen für Messungen auf Wellen

Length of base Basislänge	Possible shaft diameter Messbarer Wellendurchmesser		
L	A	B	Ø
100 mm	30 mm	21 mm	Ø 17 ... 80 mm
100 mm	32 mm	22 mm	Ø 17 ... 84 mm
150 mm	35 mm	24.5 mm	Ø 17 ... 94 mm
200 mm	40 mm	28 mm	Ø 19 ... 108 mm
250 mm	45 mm	31.5 mm	Ø 19 ... 120 mm
300 mm	50 mm	35 mm	Ø 22 ... 135 mm
500 mm	60 mm	42 mm	Ø 22 ... 160 mm
110 mm	150 mm	130 ... 140 mm	Ø 120 ... 1000 mm
150 mm	150 mm	130 ... 140 mm	Ø 120 ... 1000 mm
200 mm	150 mm	130 ... 140 mm	Ø 120 ... 1000 mm

Special executions on demand
Sonderausführungen auf Anfrage

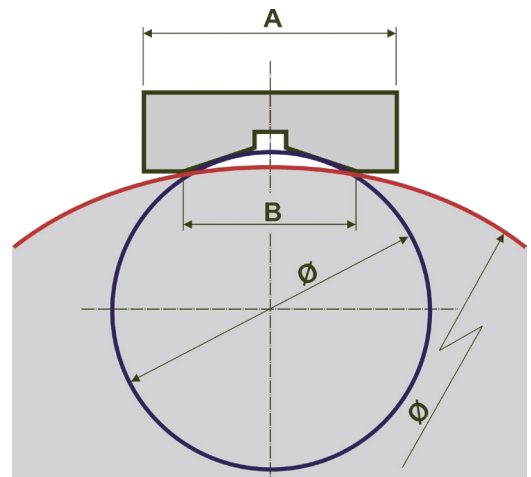
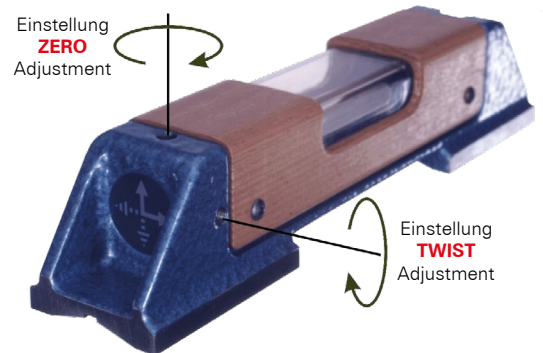

Communication Water Level 77
Präzisions-Schlauchrichtwaage 77



Horizontal Spirit Level 55 SPIRIT
Horizontal-Richtwaage 55 SPIRIT



Magnetic Spirit Level 48 SPIRIT
Magnet-Richtwaage 48 SPIRIT

Magnetic Spirit Level 58 SPIRIT
Magnet-Richtwaage 58 SPIRIT

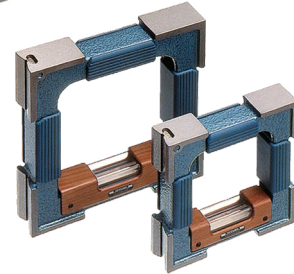

Adjustable Spirit Level 52
Einstellbare-Richtwaage 52



Clinometer 80
Clinometer 80

Adjustable Spirit Level 68
Einstellbare-Richtwaage 68



Cross Spirit Level 72/73/74
Kreuz-Richtwaage 72/73/74

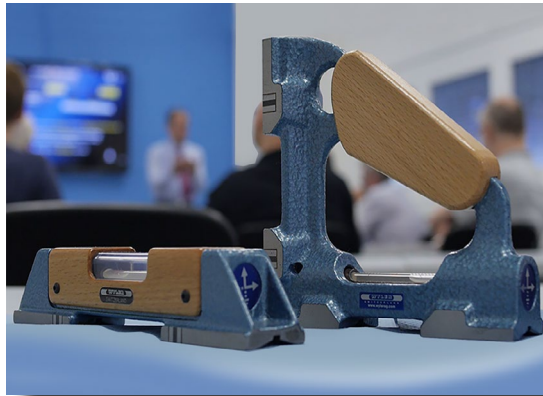

Micrometric Spirit Level 53
Feinmess Mikrometer-Richtwaage 53



Cross Spirit Level 76
Kreuz-Richtwaage 76

Crankpin Spirit Level 56
Kurbelzapfen-Richtwaage 56



Cross Spirit Level 78
Kreuz-Richtwaage 78

Shaft Spirit Level 63
Wellenrichtwaage 63

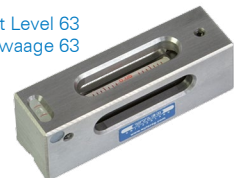

Universal Angle Spirit Level 64
Universal-Winkelrichtwaage 64

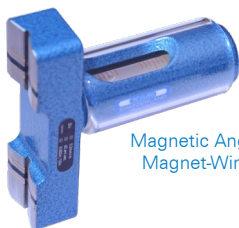

Magnetic Angle Spirit Level 47
Magnet-Winkelrichtwaage 47

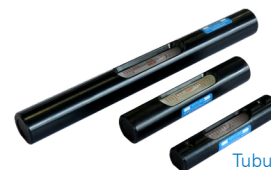

Tubular Spirit Level 59
Rohrrichtwaage 59

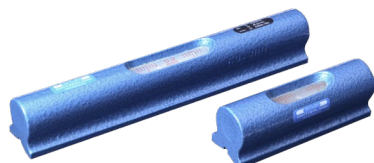

Horizontal Spirit Level 69
Horizontal-Richtwaage 69



Screw-on Spirit Level 66
Aufschraub-Richtwaage 66

CIRCULAR SPIRIT LEVELS

72 / 73 / 74

DOSENLIBELLEN

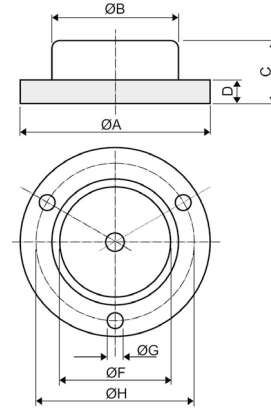

Application

- The Circular Spirit Level 72 are suitable for erection and leveling of machines and apparatus.

Anwendung

- Die Dosenlibelle 72 eignet sich hervorragend für das Aufstellen und Ausrichten von Apparaten.

Diameter A Durchmesser A	Height C Höhe C	Ø B	D	Ø F	Ø G	Ø H	Weight (gross) Gewicht (brutto)	Scale division value Skalenteilungswert	P/N Produktnummer
/ mm	/mm	/mm	/mm	/mm	/mm	/mm	/ kg	/ (arcmin)	
20	9	13.5	3	9.5	1.8	17	0.01	20 ... 30	172-20-120
25	10	17	2.5	11.5	2.7	21.3	0.01	20 ... 30	172-25-120
30	10	17	3.5	11.5	2.8	24	0.02	20 ... 30	172-30-120
40	12	25	4	17	2.8	34	0.04	12 ... 18	172-40-120
50	15	34	5.5	25	3.5	43	0.08	12 ... 18	172-50-120
60	17	39	7	30	3.5	50	0.15	8 ... 12	172-60-120

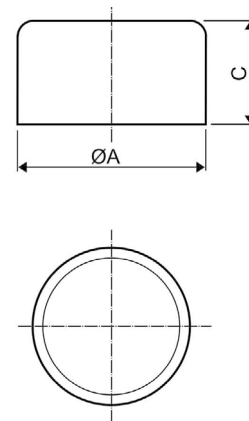

Application

- The Circular Spirit Level 73 are suitable for erection and leveling of machines and apparatus.

Anwendung

- Die Dosenlibelle 73 eignet sich hervorragend für das Aufstellen und Ausrichten von Apparaten.

Diameter A Durchmesser A	Height C Höhe C	Weight (gross) Gewicht (brutto)	Scale division value Skalenteilungswert	P/N Produktnummer
/ mm	/mm	/ kg	/ (arcmin)	
16	10	0.01	10 ... 20	173-16-120
18	10	0.01	10 ... 20	173-18-120
20	10.5	0.01	10 ... 20	173-20-120
25	12	0.02	10 ... 20	173-25-120
30	14.5	0.02	10 ... 20	173-30-120

CIRCULAR SPIRIT LEVELS **72 / 73 / 74** **DOSENLIBELLEN**

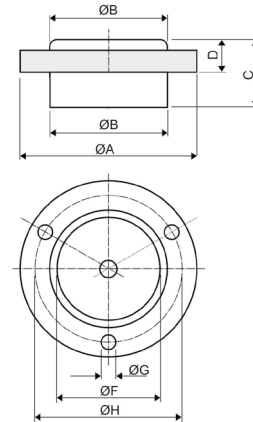

Application

- The Circular Spirit Level 74 are suitable for erection and leveling of machines and apparatus.

Anwendung

- Die Dosenlibelle 74 eignet sich hervorragend für das Aufstellen und Ausrichten von Apparaten.

Diameter A Durchmesser A	Height C Höhe C	Ø B	D	Ø F	Ø G	Ø H	Weight (gross) Gewicht (brutto)	Scale division value Skalenteilungswert	P/N Produktnummer
/ mm	/mm	/mm	/mm	/mm	/mm	/mm	/ kg	/ (arcmin)	
20	9	13.5	3.8	9.5	1.8	17	0.01	20 ... 30	172-20-120
25	10	17	4	11.5	2.7	21.3	0.01	20 ... 30	172-25-120
30	10	18	4.3	13.3	2.8	24	0.02	20 ... 30	172-30-120
40	12	25	5.5	17	2.8	34	0.04	12 ... 18	172-40-120

Scope of delivery	P/N Produktnummer	Lieferumfang
CCross Spirit Level 72 / 73 / 74	See above / Siehe oben	Kreuz-Richtwaage 72 / 73 / 74

Calibration certificate	P/N		Produktnummer	Kalibrierzertifikat
SCS calibration certificate for Circular Spirit Levels 72 / 73 / 74		SCS WW-H		SCS-Kalibrierzertifikat für Dosenlibellen 72 / 73 / 74



Quality

Service
+ Partnership

Innovation
+ Competence

Qualität

Service
+ Partnerschaft

Innovation
+ Kompetenz

WYLER SWITZERLAND is continuously enhancing their products and reserves the right to change technical specifications as well as the appearance without prior notice. For this reason the specifications and the pictures of the products delivered may be slightly different from those shown in the catalogue.

Die Firma WYLER AG ist stets um Produktverbesserungen bemüht und behält sich das Recht vor, die technischen Daten und das äussere Erscheinungsbild jederzeit und ohne Vorankündigung zu ändern. Aus diesem Grund können die Spezifikationen und die Abbildungen der Produkte zum Teil leicht vom Katalog abweichen.



WYLER AG
INCLINATION MEASURING SYSTEMS
NEIGUNGSMESSSYSTEME

Im Hölzli 13, CH-8405 WINTERTHUR (Switzerland)
 Tel. +41 (0) 52 233 66 66 Fax +41 (0) 52 233 20 53
 E-Mail: wyl@wyl.com Web: www.wyl.com

