



# WORKSWELL SAFETIS OUTDOOR EARLY FIRE DETECTION THERMAL CAMERA

**Release date:** 13<sup>th</sup> of April 2021

**Revision Number:** 210413

Workswell s.r.o. introduces the new Thermal Imaging System designed for early fire detection and protection **Workswell SAFETIS Outdoor**. The wide usage of the product can be applied in many Fire-Safety fields requiring 24/7 protection such as waste bunkers, many types of warehouses, electrical substations, landfills, photovoltaic plants etc. Workswell pushed the limits forward and developed unique all-in-one system with built-in analysis, continuous measurement, visualization, control functions and alarming. **SAFETIS Outdoor** camera can be used and controlled via integrated Web-server or via **SAFETIS Control Unit** with advanced features.

**Workswell SAFETIS Outdoor** camera offers great resolution of 640 x 512 px, sensitivity of 50 mK (0.05 °C) and fast response within milliseconds. The powerful communication interface allows connecting SAFETIS camera directly to any computer via Web-server or directly to **SAFETIS Control Unit** via Ethernet RJ45. The SAFETIS camera has integrated 7 digital outputs in the camera and 7 digital outputs in **SAFETIS Control Unit** that can be triggered at the same time if needed.



### **KEY FEATURES IN SAFETIS OUTDOOR**

- Built-in **web-server** for control and stream
- **SAFETIS Control unit** for advanced visualization
- **High-protection heated outdoor housing IP67**
- Fully calibrated up to 550 °C (optional +1 500 °C)
- Resolution 336 px or 640 px detector up to 30 Hz
- Ethernet TCP/IP Process communication
- **Up to 7 digital alarm outputs in the camera**
- Infinity focus or optional focusing on target
- Advanced analytics, recording and alarming



<b>SAFETIS Outdoor specification table</b>			
<b>Resolution</b>	336 x 256 pixels		640 x 512 pixels
<b>Image frequency</b>	9 Hz or 30 Hz		9 Hz
<b>Temperature ranges</b>	-25 °C to +150 °C (-13 °F to 302 °F) -40 °C to +550 °C (-40 °F to 1 022 °F) optional temperature range +50 – 1 000 °C (122 °F to 1 832 °F) optional temperature range +400 – 1 500 °C (752 °F to 2 732 °F)		
<b>Temperature sensitivity</b>	0.05 °C (50 mK)		
<b>Spectral range</b>	7.5 – 13.5 μm		
<b>Detector type</b>	Uncooled VOx microbolometer		
<b>Focus</b>	Continuous manual (fixed focusable, min focus distance depends on lens)		
<b>Calibration</b>	Yes, including calibration certificate		
<b>Web server</b>	Yes, integrated with additional early fire detection functions		
<b>FOV/Focal length 640 x 512</b>	<b>iFOV</b>	<b>Accuracy</b>	<b>Pixel size</b>
FOV 90° x 69° / 7.5 mm	2.267 mrad	±3 % or ±3 °C, MTF @ 70% of FOV Distortion of 5%	2.3 mm from 1 meter
FOV 69° x 56° / 9 mm	1.889 mrad	±2 % or ±2 °C	1.9 mm from 1 meter
FOV 45° x 37° / 13 mm	1.308 mrad	±2 % or ±2 °C	1.3 mm from 1 meter
FOV 32° x 26° / 19 mm	0.895 mrad	±2 % or ±2 °C	0.9 mm from 1 meter
<b>FOV/Focal length 336 x 256</b>	<b>iFOV</b>	<b>Accuracy</b>	<b>Pixel size</b>
FOV 45° x 35° / 6.8 mm	2.267 mrad	±2 % or ±2 °C	2.3 mm from 1 meter
FOV 35° x 27° / 9 mm	1.889 mrad	±2 % or ±2 °C	1.9 mm from 1 meter
FOV 25° x 19° / 13mm	1.308 mrad	±2 % or ±2 °C	1.3 mm from 1 meter
FOV 17° x 13° / 19mm	0.895 mrad	±2 % or ±2 °C	0.9 mm from 1 meter
<b>SAFETIS Outdoor built-in functions (integrated web-server)</b>			
<b>Camera configuration</b>	Built-in web-server for easy and fast sensor configuration, Google Chrome, Safari, Explorer or Firefox browser compatible, no external software required		
<b>Monitoring and alarming</b>	Extreme detection, MAX/MIN evaluation, Dynamic/Static measurement User Control Table (Logical rules and PLC connection), Selectable digital output for specific ROI result (OR/AND operators)		
<b>Visualization</b>	Real-time video streaming, Pallet settings, Overlay elements, Digital zooming, Numeric and statistical indicators, Input and Output overview panel		
<b>Image correction</b>	Non-Uniformity Correction asynchronous/synchronous/triggerable		
<b>ROI</b>	User definable measurement area (Point, Line, Polyline, Rect., Polygon, Circle) Multiple product selection for ROI presets (Manual or via Ethernet)		
<b>Others</b>	Real-time Clock, Emissivity correction, Multiple languages		



**SAFETIS Outdoor functions connected to SAFETIS CONTROL UNIT via SDK**

<b>Camera configuration</b>	Camera is completely configured via SAFETIS SDK or web-server
<b>Number of cameras</b>	Up to 16 cameras connected to single SAFETIS Control unit
<b>Monitoring and alarming</b>	Advanced analytics functions, Extreme detection, MAX/MIN evaluation, Dynamic/Static measurements, User Control Table (Logical rules for PLC connection), Selectable digital outputs for specific ROI measurement analysis
<b>Advanced analytics functions</b>	Yes, eliminating of non-alarm triggers, eliminating of moving objects etc.
<b>Graphical alarm visualization</b>	Yes
<b>Recording</b>	Pre-alarm recording function allows to start recording before the alarms appear
<b>Image recording</b>	Yes
<b>Fully radiometric recording</b>	Yes
<b>Logging</b>	Yes
<b>Visualization</b>	Real-time video streaming from up to 16 cameras, Pallet settings, Overlay elements, Digital zooming, Numeric and statistical indicators
<b>Visualization on desktop</b>	Visualization can be reorganized according to customer wish
<b>Graphs visualization from ROI</b>	Yes
<b>ROI</b>	User definable measurement area (Point, Line, Polyline, Rect., Polygon, Circle)
<b>Digital outputs</b>	Up to 14 digital outputs (7 on the camera, 7 on the SAFETIS Control unit)
<b>Network and I/O connectivity</b>	
<b>Network</b>	Ethernet for streaming and control (IEEE 802.3)
<b>Network connectivity</b>	Ethernet 100Mb/sec, RJ-45, Metal cable gland protection
<b>Digital outputs on the camera</b>	7 x Isolated open collector output (max 40 VDC), M12 circular thread
<b>Environmental data, dimensions and power supply</b>	
<b>IP protection (Encapsulation)</b>	IP67 with cable glands
<b>Operating temperature</b>	-25°C to +50°C (-13 °F to 122 °F)
<b>Automatic heaters</b>	Yes, including clearing the window from ice
<b>Storage temperature</b>	-40°C to +70°C (-40 °F to 158 °F)
<b>Humidity</b>	5% to 95% non-condensing
<b>Dimensions and weight</b>	493 x 175 x 168 mm, 5.3 kg, durable aluminum body
<b>Supply input, consumption</b>	230 VAC/ 110 VAC, < 20 W
<b>Mounting</b>	More information in the housing datasheet



# SAFETIS BUILT-IN WEB-SERVER

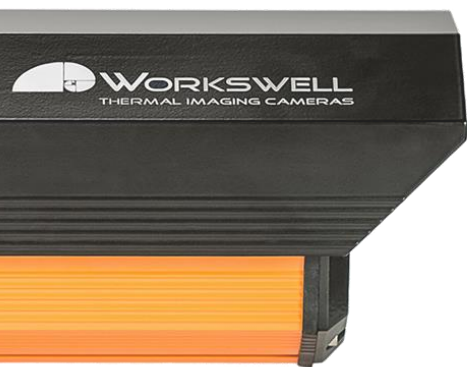
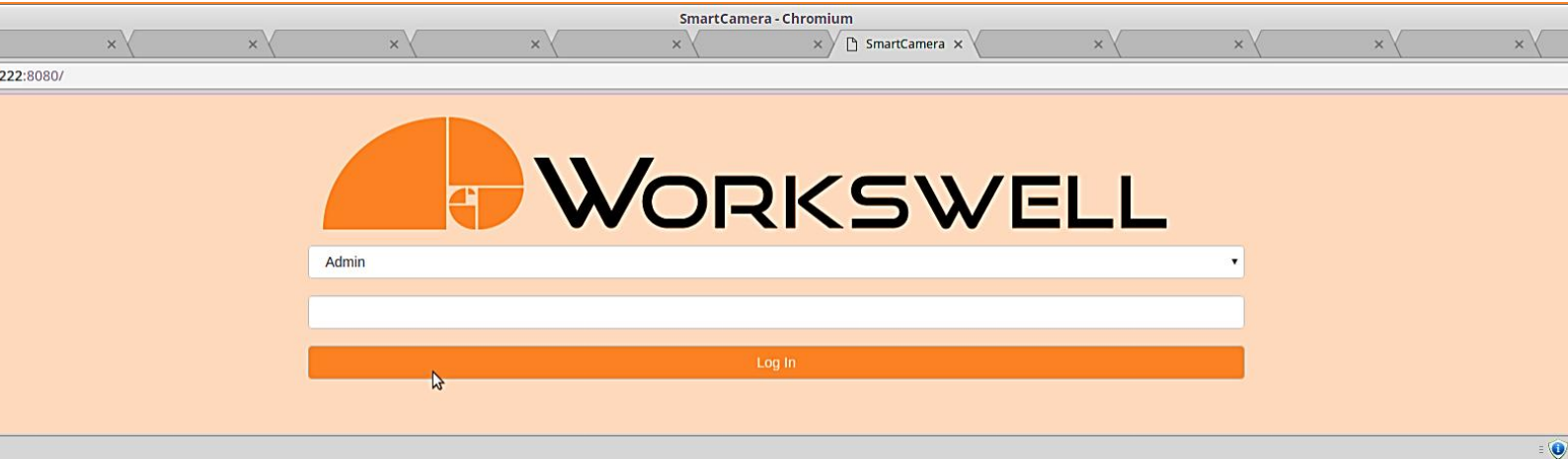

## Web-server Key Points

- No external software needed and Windows, Linux or Mac OS fully compatible
- Full camera control and image streaming via standard web browser
- User-friendly configuration wizard with multiple user access mode
- Integrated operator visualization with indicator panel
- Available via Ethernet cable or wireless connectivity
- Camera updates
- Multilanguage

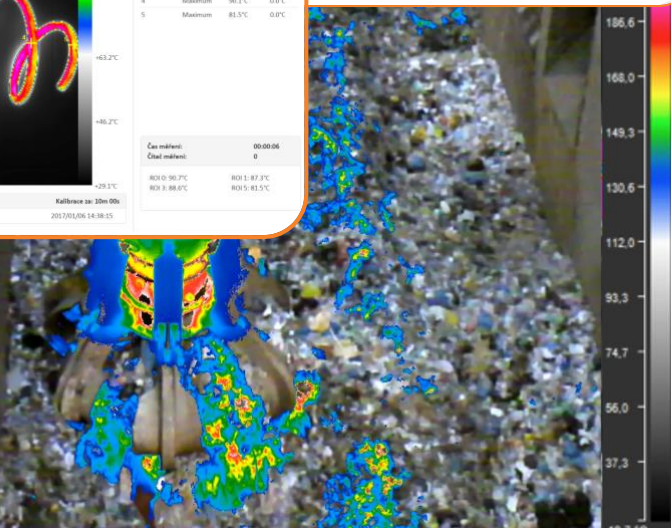
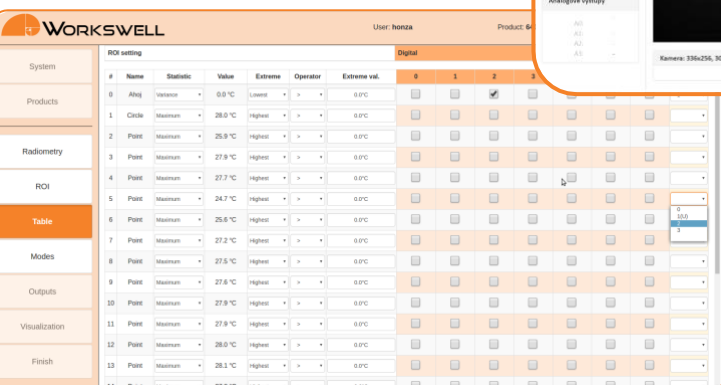
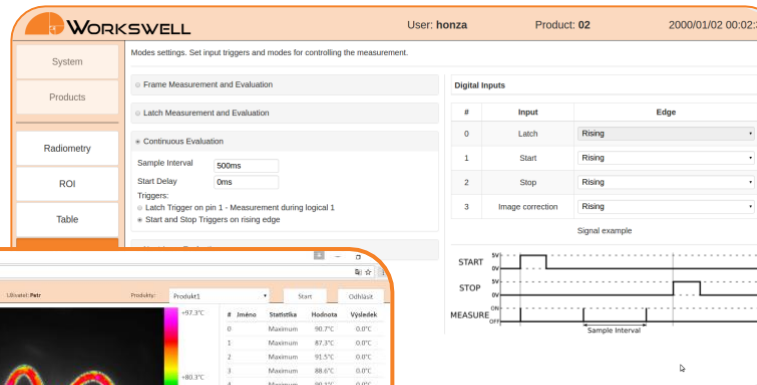



# SAFETIS Control Unit – advanced 24/7 monitoring

- Up to 16 SAFETIS cameras at the same time
- Real-time streaming of each connected SAFETIS
- Advanced visualization and recording functions
- Start recording of radiometric video up to 30 s before alarm (pre-trigger), during alarm and 30 s after alarm
- Periodical recording of radiometric images
- Live graphs based on temperature values
- Position control of any connected SAFETIS Pan-Tilt
- Settings of all parameters of any connected SAFETIS
- 7 digital outputs

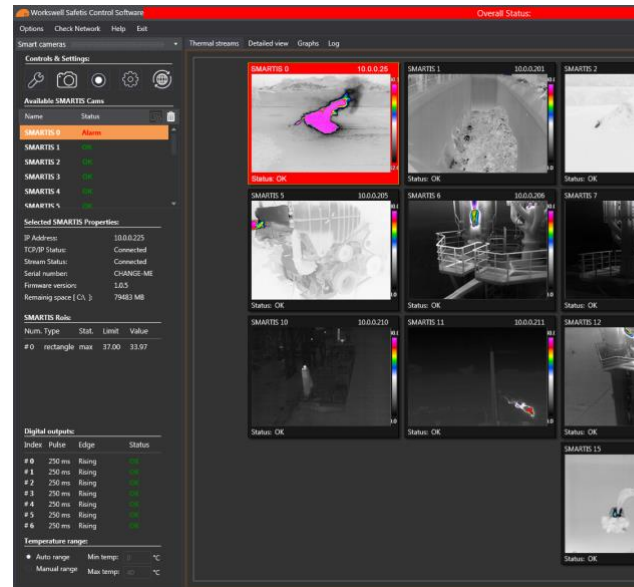

**SAFETIS Control Unit** has been developed for complex early fire detection and protection requiring 24/7 monitoring. This allows you to prevent critical situations and fire hazards that can damage huge values of company properties. Thanks to advanced SAFETIS Control Unit features, **all alarms are activated even before any fire related event starts**. The SAFETIS Control Unit is a special industrial controller with SDK software and sample Labview application for parameterization and visualization. The SAFETIS Control Unit is available in two versions for 8 or 16 SAFETIS cameras.

**SAFETIS Control Unit** allows to combine any kind of SAFETIS cameras, no matter if it is Outdoor, Indoor, EX-proof, Outdoor PT, Stainless Steel, low / high resolution or frame rate.

4 Disk Drive, max **8TB**  
**RAID 0, 1, 5, 10**

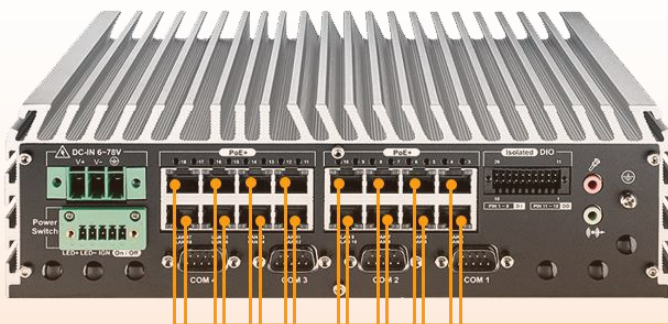

up to 16 cameras  
at the same time



## SAFETIS Outdoor dimensions (in millimeters)

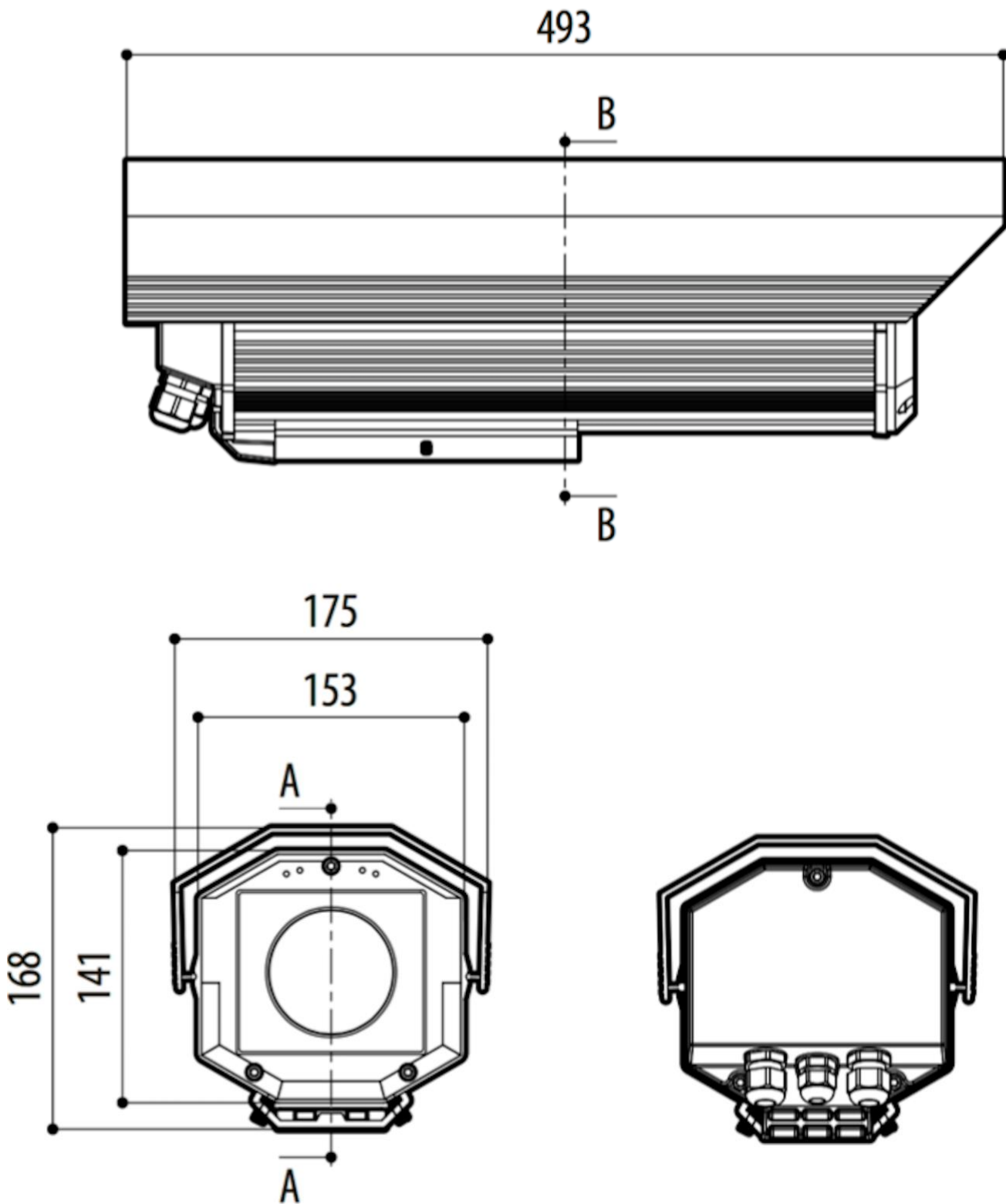

# Contact information

WORKSWELL IN THE WORLD

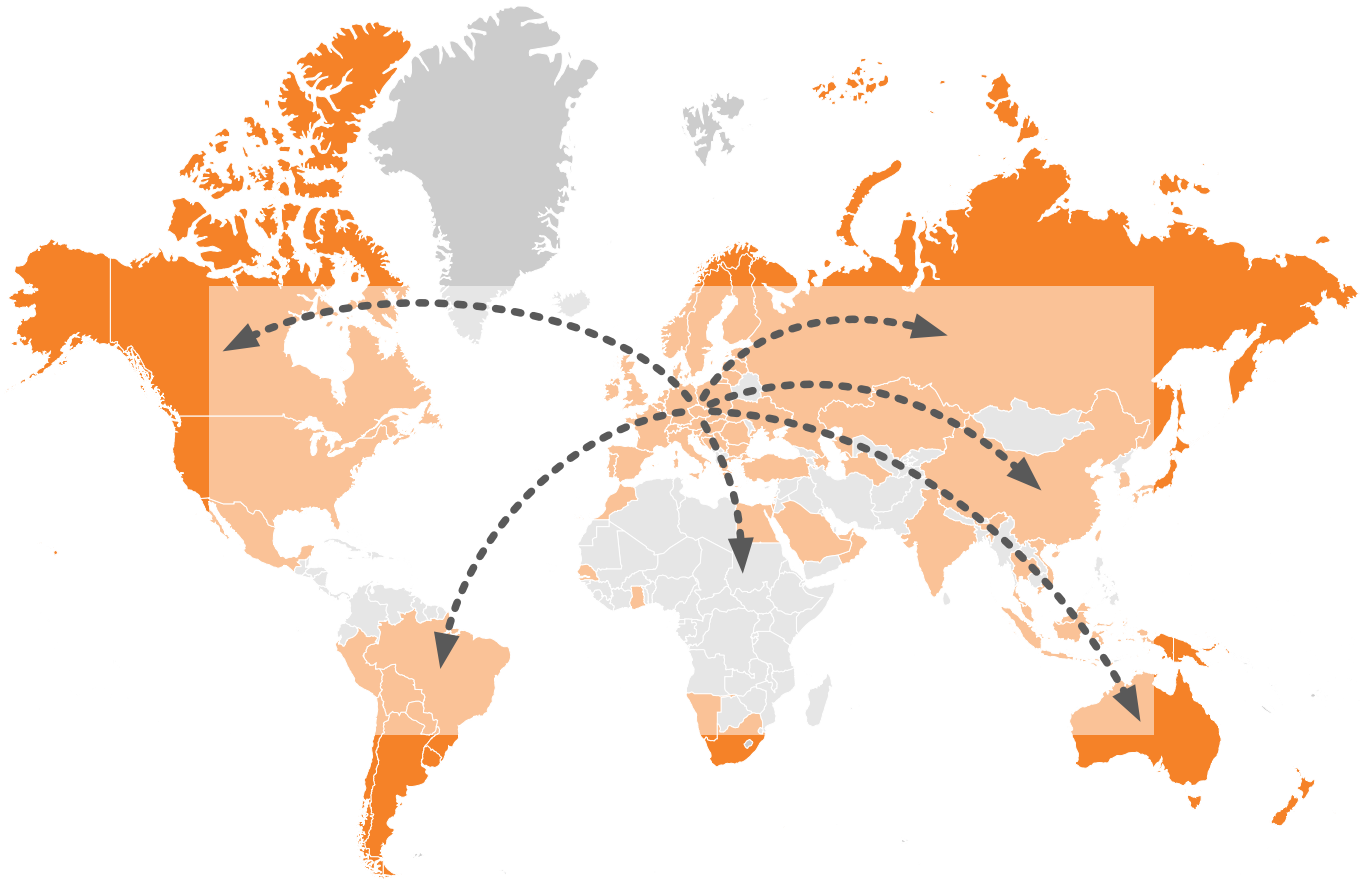

## Our partner in Mexico



Tecnología Avanzada para Mantenimiento, S.A. de C.V.

800-8373-TAM (800-8373-826)

Privada de los Misterios 1. Esq. Av. de los Arcos. Col. Calesa. 76020. Querétaro, Qro. MEXICO  
Conmutador: (442) 248 1470 • Fax: (442) 248 1471 • [ventas@tam.com.mx](mailto:ventas@tam.com.mx)

[www.tam.com.mx](http://www.tam.com.mx)

